

WC CONNECTOR WALL FLANGES

To fit over 110mm Pipe



Code: WC-17-110

To fit over Collar of
Flexible WC Connector



Code: WC-17-114

ANTI CROSS-FLOW AND RODENT BARRIER VALVE

- Will prevent cross-flow if fitted to WC Pans that are installed back to back.
- For use where special measures are necessary for control of rodents as recommended in Approved Document H1: The Building Regulations 2000 (2002 edition).
- In black polypropylene to prevent light penetration.
- Prevents rodents from entering building through WC.
- For use with any McAlpine WC Connector with 4" / 110mm rubber outlet seal.
- Can be installed in horizontal or vertical position.

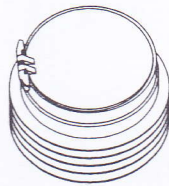

Closed position

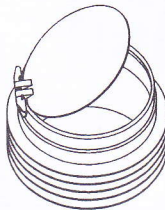

Open position

Code:

ARB-1

BOSS PIPE FOR USE WITH WC CONNECTORS

- In white polypropylene.
- Fitted seal spigot for internal connection to cast iron, plastic or clay 4" / 110mm pipe.
- Ideal for low level connections.

3 1/2" / 90mm x 4" / 110mm Connector. O' Seal socket to fit WC Connector with 3 1/2" / 90mm plain end with 1 1/2" Universal Pipe Boss including Blanking Cap.

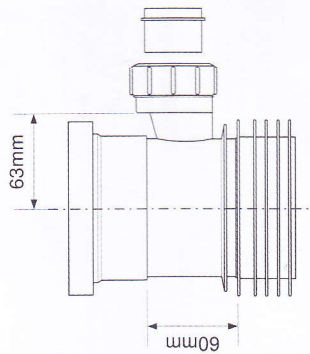

Code:

WC-BP1



McALPINE & CO. LTD.,

Kelvin Avenue, Hillington,
Glasgow G52 4LF.

Telephone: 0141-882 3213

Fax: 0141-891 5065

Fax: Orders (Sales Office) 0141-883 5697

Website: www.mcalpineplumbing.com

McALPINE
Plumbing Products

Rigid, Flexible and MACFIT WC Connectors

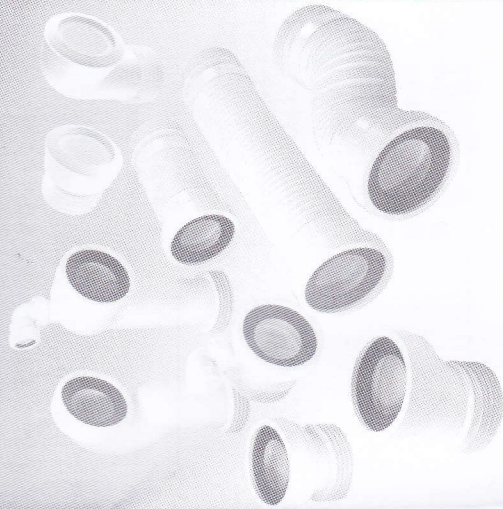

Flexible WC Connectors

- All inlet seals will fit 90-114mm diameter pan spigot.
- WC-F23R : WC-F26R ; WC-F23RV : WC-F26RV : WC-CON8F and WC-CON8FV fit inside 4" / 110mm diameter pipe.
- WC-F23S : WC-F26S ; WC-F23SV and WC-F26SV fit inside 3 1/2" / 90mm diameter pipe.
- Connectors with a plain end have an outside diameter of 110mm.
- All Connectors with 1 1/4" Universal Boss include Blank Cap with 1 1/2" BSP Thread.
- Installations requiring an extended straight length should be supported firmly to prevent any sagging.
- Do not attempt to clear blockages with the use of drain rods.
- For ease of fitting, the inlet seal should be lubricated with water, not grease.
- Do not over extend or pull flex off inlet and outlet locations. Extend flex by pulling from the middle of the flex and not from the fixture locations.

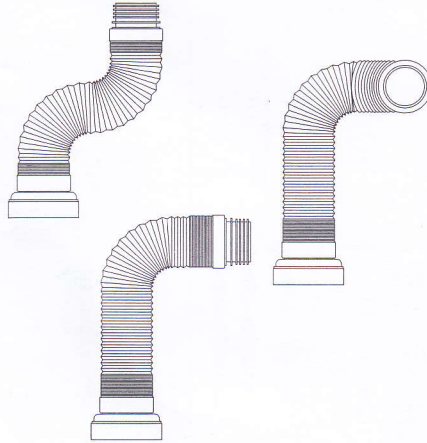

STANDARD CONNECTORS

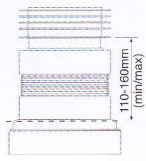

Code: WC-F18R

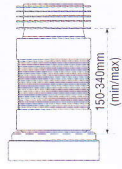

Code: WC-F23R

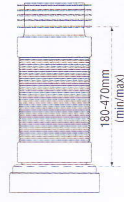

Code: WC-F26R

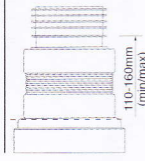

Code: WC-F18S

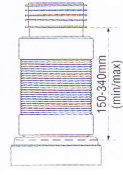

Code: WC-F23S

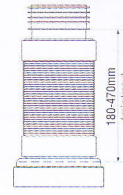

Code: WC-F26S

STANDARD CONNECTORS

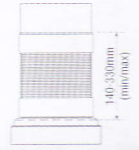

Code: WC-F23P

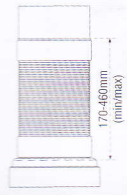

Code: WC-F26P

CONNECTORS WITH 1 1/4" UNIVERSAL BOSS

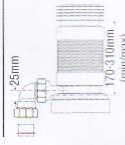

Code: WC-F23RV

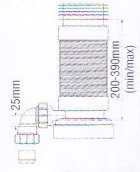

Code: WC-F26RV

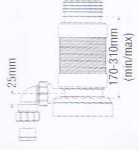

Code: WC-F23SV

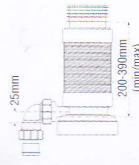

Code: WC-F26SV

CONNECTORS WITH 1 1/4" UNIVERSAL BOSS

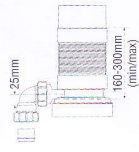

Code: WC-F23PV

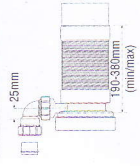

Code: WC-F26PV



Code: WC-CON8F

Code: WC-CON8FV

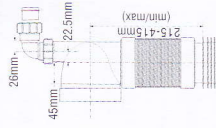

Code: WC-CON8FV

MACFIT

(patent pending)

WC Connectors

Manufactured in EVA

- Tested to BS 5627 : 1984
- Inlet seals will fit Pans manufactured to BS 5503/4 and BS 1213.
- Outlet seals will fit inside 4" / 110mm diameter pipe except MAC-EXTB which fits inside 3 1/2" / 90mm pipe and MAC-EXTC which fits inside 3" / 75mm pipe.
- For ease of fitting inlet and outlet seals should be lubricated with water NOT GREASE.

90° Space Saving Bend.
Adjustable Length.

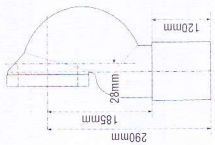

Code: WC-CONQP

45° Angle.

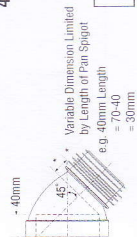

Code: WC-CON16

Straight Extension.
Adjustable Length.

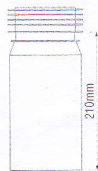

Code: WC-EXTA

Straight Extension
Reducer.
Adjustable Length.



Code: WC-EXTB

10mm Offset Extension
Adjustable Length.



Code: WC-EXTC

10mm Offset Extension
Reducer.
Adjustable Length.

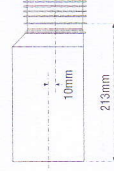

Code: WC-EXTD

40mm Offset.
4"/110mm Outlet.

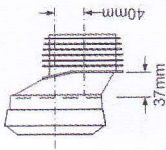

Code: MAC-4A

14° Angle.
4"/110mm Outlet.

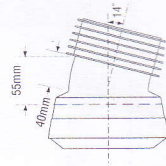

Code: MAC-7A

90° Bend.
4"/110mm Outlet.
Non Adjustable.

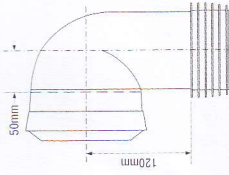

Code: MAC-8

90° Bend (Long).
4"/110mm Outlet.
Non Adjustable.

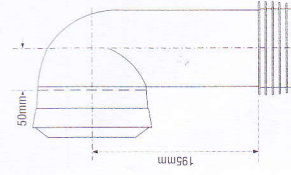

Code: MAC-8L

Straight Extension.
4"/110mm Outlet.

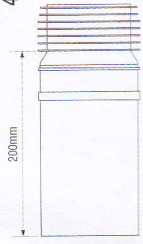

Code: MAC-EXTA

Straight Extension.
3 1/2"/90mm Outlet.

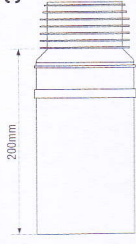

Code: MAC-EXTB

Straight Extension.
3"/75mm Outlet.

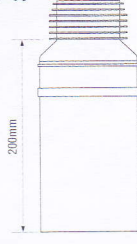

Code: MAC-EXTC

Linking Connector
(Polypropylene).

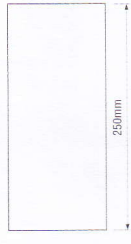

Code: MACLINK

Rigid WC Connectors

- Tested to BS5627.
- All inlet seals will fit 90-114mm diameter pan spigot except WC-CON8E, which is 90-110mm.
- All outlet seals will fit inside 4"/110mm diameter pipe except WC-CON2B, WC-CON5B, WC-CON7B, WC-EXTB and WC-EXTD which fit inside 3 1/2"/90mm diameter pipe.
- Connectors with a plain end have an outside diameter of 110mm.
- A suitable lubricant such as Silicone Grease can be applied to the bore of the Pipe before assembly.

Straight.

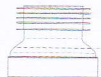

Code: WC-CON1

Straight. 1/4" Universal Pipe Boss, including Blanking Cap with 1/2" BSP Thread.

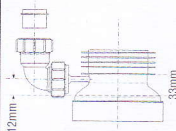

Code: WC-CON1V

Straight. Adjustable Length.



Code: WC-CON2

Straight Reducer. Adjustable Length.



Code: WC-CON2B

Straight. Adjustable Length.



Code: WC-CON3

20mm Offset.



Code: WC-CON4

40mm Offset.

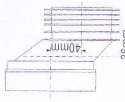

Code: WC-CON4A

40mm Offset.

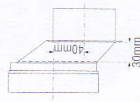

Code: WC-CON4B

20mm Offset. Adjustable Length.



Code: WC-CON5

24mm Offset Reducer. Adjustable Length.



Code: WC-CON5B

20mm Offset. Adjustable Length.



Code: WC-CON6

14° Angle. Adjustable Length.



Code: WC-CON7

14° Angle.

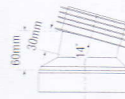

Code: WC-CON7A

14° Angle Reducer. Adjustable Length.

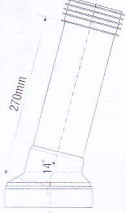

Code: WC-CON7B

90° Bend. Adjustable Length.

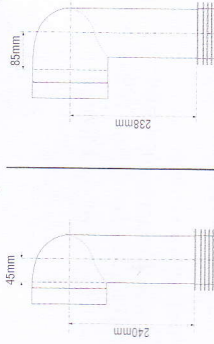

Code: WC-CON8

Code: WC-CON8E

90° Bend. 1/4" Universal Pipe Boss, including Blanking Cap, with 1/2" BSP Thread. Adjustable Length.

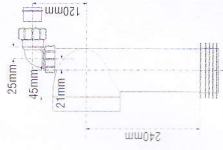

Code: WC-CON8V

90° Bend. Adjustable Length.



Code: WC-CON9

90° Bend. 1/4" Universal Pipe Boss, including Blanking Cap, with 1/2" BSP Thread. Adjustable Length.

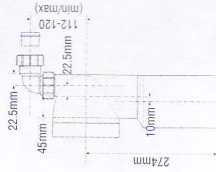

Code: WC-CON9V

90° Space Saving Bend. Adjustable Length.

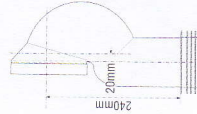

Code: WC-CON9